

# TACHULATOR MODULE

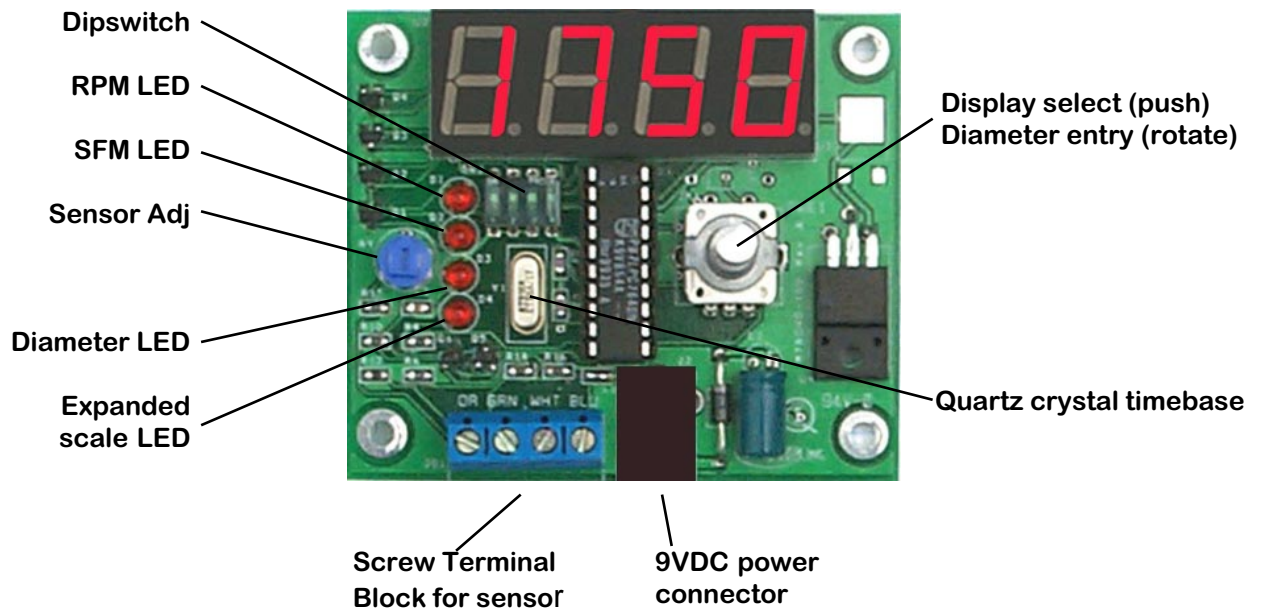

## Applications:

- Machine tools- lathes, milling machines
- Wood tools- lathes, routers
- Conveyors
- Mixers
- Peristaltic pumps

## Features:

- **Period counting for fast updates even at slow RPM inputs**
- **Calculates SFM from RPM and entered diameter**
- Cutter or work diameter from 0.01" to 99.99"
- **Low power consumption- 50mA typically at 9-12VDC**
- Bright attractive 4 digit 0.56" high display with decimal points
- Sensor contains light source- will work in complete darkness
- Crystal timebase for high accuracy and stability
- **Professional quality conservative design and manufacturing**
- **Screw terminal block for sensor connection.**
- **Usable with multiple sensor heads using a DPDT or 2-pole multiple-position switch**

## Specifications:

Resolution:	1RPM
Accuracy:	+/- 1RPM
Range:	50-9999 RPM with 1 pulse/rev 5-9999 RPM with 10 pulses/rev 3-9999 RPM with 16 pulses/rev
Focus Distance:	0.150" (3.81mm)
Light source:	Internal IR LED
Diameter setting:	0-99.99"
SFM display:	0-9999 SFM
Power supply:	DC 9V-12V @ 50mA typ.
Operating temperature:	0-55°C (20-130°F)
Humidity:	10-90% non-condensing
Size:	2.9" w x 2.45" h x 0.75" d (d not including shaft length)

## Ordering Info:

Part number: MTACHO-100



manufactured by Trexon Inc.  
sales@trexon.com  
<http://www.trexon.com>

Represented by:

# Optical Pickup:

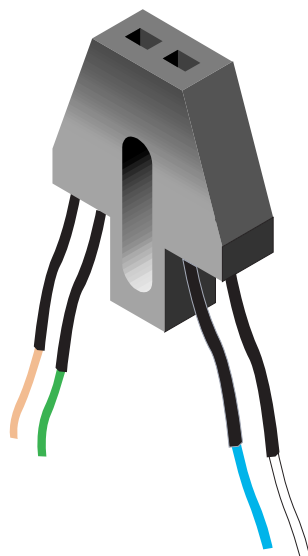

Note: Actual lead length is 24" (600mm)

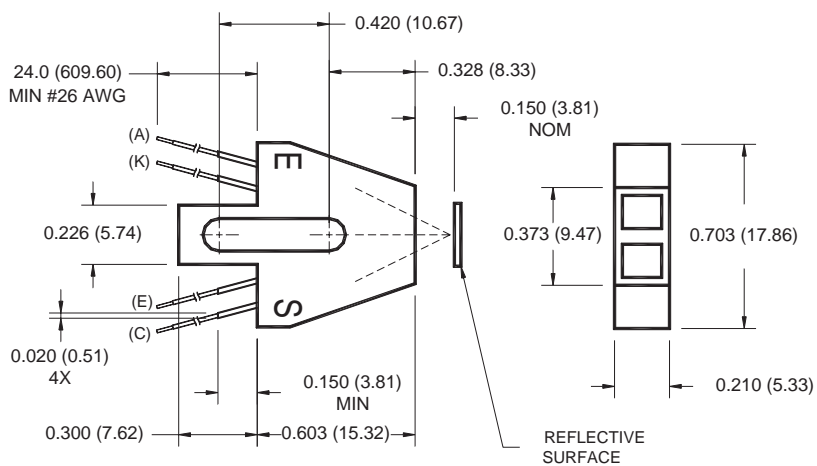

FUNCTION	WIRE COLOR
(C) COLLECTOR	WHITE
(E) EMITTER	BLUE
(K) CATHODE	GREEN
(A) ANODE	ORANGE

## Board Dimensions:

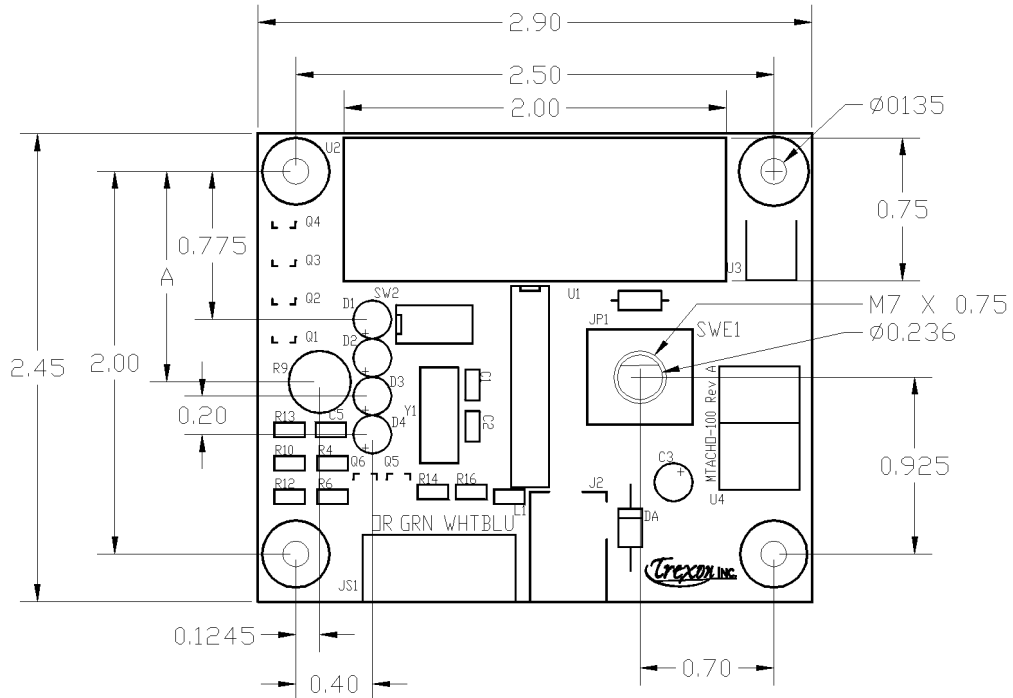

Notes:  
Dimension "A" T.B.D. (typically 1.1" ~ 1.2")

## Installation:

The board is supplied without a housing. Install the board so that it is protected from heat, moisture and away from extreme vibration. The sensor should be mounted about 0.1 to 0.15" from the marked surface being sensed, out of direct light. Disks with 1 and 10 marks are included in this manual; you may print them out for use with this tachometer module. For best performance at high RPM, the black and white areas should be equal.

Power is supplied by a 9VDC output wall-plug adapter with a 2.1mm $\varnothing$  center-negative pin. Power requirement is typically less than 50mA; we recommend an adapter rated from 9-12VDC at 100mA to 1000mA. No heat sinking is required. Due to reverse-polarity protection the display will remain blank if a center-positive adapter is plugged into the unit. Applying more than 12VDC may cause severe damage to the unit.

## Setup:

The trimpot ("Sensor Adj") is used to adjust sensitivity of the sensor, to compensate for differences in the sensors and mounting distance and mark reflectivity. It should be adjusted between two points where the tachulator fails to work, and left in the middle. Often the factory setting of center is adequate if there is good contrast in the markings. A plastic corrugated wire loom may be used to protect the sensor wires if they must go external to a housing. Avoid running the wires alongside power electrical wires, or extending them unnecessarily. Shielding may be required if they are extended- 4-core microphone cable may be used. For use with more than one sensor, see the schematic at the end of this manual. Use the DIPSWITCH to set the number of marks per rotation as shown in the table below.

## Operation:

With power applied the Tachulator will show “----” for a short period of time when power is first applied. The top LED, indicating RPM, will light. After a couple of seconds it will then display the speed or “0”.

Pushing on the shaft will cycle the LEDs from:

















- Top: RPM
- 2nd: SFM (will read zero until diameter has been entered)
- 3rd: Diameter (allows entry of diameter of cutter or lathe workpiece)

The bottom LED is used to indicate “expanded scale” operation, explained below.

To enter the Diameter, push the knob until the 3rd LED from the top is lit. Turn the knob to set the diameter in the display. Push the knob once to advance the display to RPM, and again if you wish to display SFM.

Expanded Scale: The Tachulator attempts to use whole rotations of the disk to measure RPM. When there are multiple marks, and the RPMs are low, it will automatically switch to using fewer than one rotation as set on the DIPSWITCH. In this mode there may be a bit more jitter in the reading if the disk is not centered in relation to the shaft. The bottom LED lights to indicate tht the expanded scale mode is in use.

## DIPSWITCH Settings:

Marks	Switch	Marks	Switch
1		9	
2		10	
3		11	
4		12	
5		13	
6		14	
7		15	
8		16	

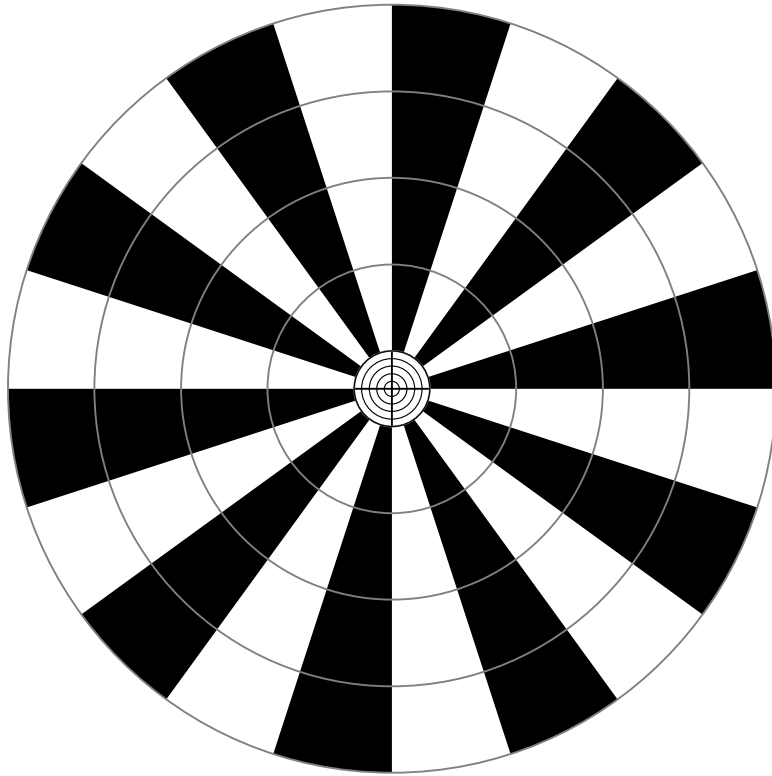

**Tachulator Encoder V1.0 10 marks**

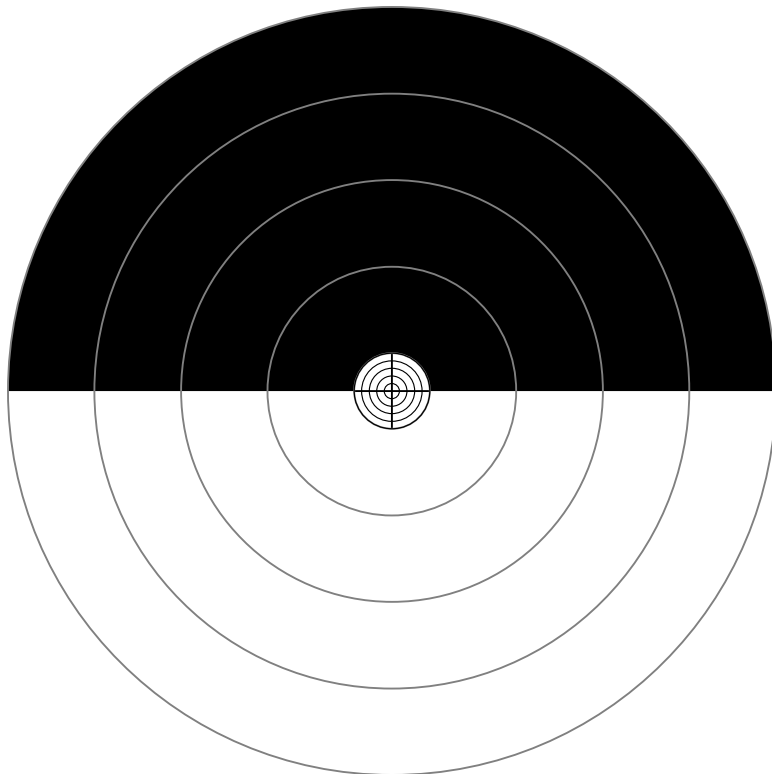

**Tachulator Encoder V1.0 1 mark**



Switch is a miniature DPDT toggle switch with gold-plated contacts.

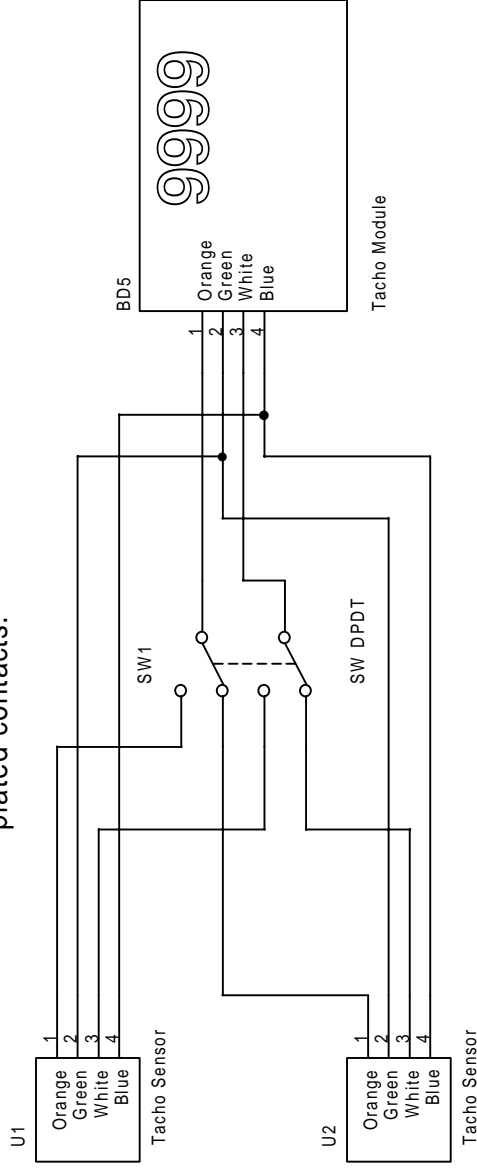

Title		Tacho Module Dual Sensor	
Size	A	Document Number	SPTACH-102
Date:	Wednesday, January 09, 2002	Sheet	1 of 1

